



MAD B2
B2-112V

MADE TO PLAY LOUD

WE PLAY LOUD!!

We know what you want. You want it LOUD, and that is exactly what we do, what we live for. Vibrations, gut-punches and straight up loud music - that's what makes us tick. We won't dress up in fancy words or claim to be something we're not. We are the NO BULLSH!T car audio brand!









Every single product with the GAS logo on it is born out of passion, the same that has driven us for two generations and that will keep us rolling up to your neighbourhood, winning and pushing the limits for many generations to come!

It's up to you to choose your own level of loud, and if you don't like what we do that's OK. You are welcome back when you've had your first true GAS experience. We don't exclude, we don't judge and we do not make up any excuses for who we are.

We are GAS and we are proud to be LOUD!

GAS

TABLE OF CONTENT

 SAFETY.....	3
 UNPACKING.....	4
 DIMENSIONS.....	4
 SPECIFICATIONS.....	5
MAD B2-112V.....	5
 FEATURES.....	6
Loaded with MAD S2 subwoofer (dual voice coil).....	6
Triangle X-bracing.....	6
Optimized slotport design.....	6
Engineered high strength terminal cup.....	6
 HOW TO.....	7
Install pre-loaded enclosure.....	7
 TROUBLESHOOTING.....	9
No power/sound.....	9
Distortion.....	9
 WARRANTY & DISPOSAL.....	10
 THE GAS WORLD.....	11



SAFETY

PLAY LOUD & SAFE. Read through this information, follow the instructions and save the manual for future usage and reference.

Make sure to pay attention to the instructions when you see this symbol: 

Do not expose your new loaded enclosure to excessive damp or moisture. If the enclosure/subwoofer is exposed it might result in electric failure, shock or damage to the product. Servicing is required when the product has been damaged in any way and/or doesn't operate normally. Refer all servicing to qualified service personnel only.

Keep the cables inside the vehicle separate from sharp edges or components that may be affected or take damage. Follow the recommended cable sizes and always use high quality cables and accessories. Even if you're eager to put the enclosure to use – take no shortcuts when installing the cables, make sure that all connectors are protected and secured.

Do not drill any holes without checking what lies beneath, and don't cut anything without making sure that no important components risk being damaged.

To avoid potential injury from enclosure movements, the pre-loaded enclosure must be securely fastened in the vehicle on a suitable location.

There is a first time for everything, if you need help – ask a friend or contact your local GAS AUDIO POWER dealer/installer.

We want you to experience your product's MAD sound, but we don't want you to injure yourself or others. Use common sense, respect high pressure levels and volume, and follow your local laws and regulations.



UNPACKING

Unboxing your new MAD product is an experience, make sure that the enclosure and all the accessories are included in the packaging:

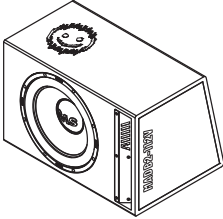

Loaded enclosure
(1pc)



Manual
(1pc)

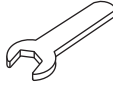

Wrench
(1pc)

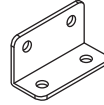

Brackets
(2pcs)



Screws
(8pcs)

DIMENSIONS

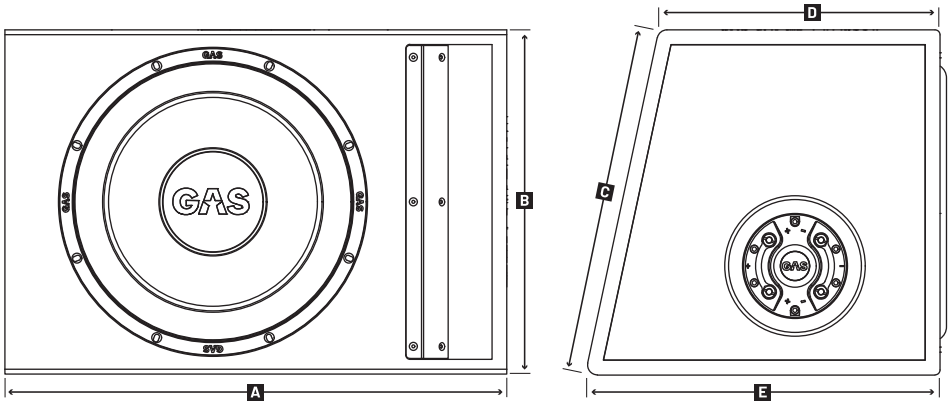

	A	B	C	D	E	
B2-112V	530	350	355	285	360	mm

SPECIFICATIONS

Below you'll find the specifications that has been checked and tested in our workshop. The specifications aren't directly connected with the sound pressure in the vehicle, and shouldn't be used as the sole indicator for comparison with other enclosures. The MAD B2 enclosures are loaded with MAD S2 subwoofers (see product specifications below).

MAD B2-112V	
Component	Pre-loaded Enclosure
Size	1x12" (300mm)
Nominal Impedance	1 / 2+2 / 4 Ohm
Power RMS	350W
Power MAX	700W
Volume	43 L
Weight	15.2 KG

MAD S2-12D2	
Component	Subwoofer
Size	12" (300mm)
Nominal Impedance	2+2 Ohm
Power RMS	350W
Power MAX	700W
Freq. response	20-200Hz
Voice Coil	2" (51mm) PCW
Cone	IMPP
Dustcap	3D IMPP
Basket	M Steel
Magnet	HQ Ferrite
Suspension	USG™ Rubber

FEATURES

The MAD enclosures are designed to be LOUD and last for years to come. Those awesome vibrations are what drives us to create impressive enclosures loaded with our subwoofers. We want to help you to be as LOUD as possible. We've made sure that's the case by using innovative and groundbreaking techniques that increase both durability and performance.

LOADED WITH MAD S2 SUBWOOFER (DUAL VOICE COIL)

The MAD B2-112V vented enclosure is pre-loaded with the awesome MAD S2-12D2 subwoofer to offer you a whole new level of LOUD! With a durable IMPP (Injection Molded Polypropylene) cone, a Unity Surround & Gasket construction (USG™), a Dual Ventilation System (DVS™) and a dual voice coil made of PCW (Pure Copper Wire) you get a subwoofer that'll impress your friends and terrify your neighbors.

TRIANGLE X-BRACING

Your LOUD lifestyle shouldn't have to be let down by lousy construction! The MAD 2 enclosures are all equipped with several Triangle X-bracings to give you a more rigid enclosure that can withstand the toughest bass challenges. This strong and durable enclosure resists heavy vibrations and resonances so you can wreak bass havoc!

OPTIMIZED SLOTPORT DESIGN

Even if LOUD is one of our core beliefs, it's also important that your sound expectations are met. We've used an optimized high output airflow slot port design in all MAD 2 enclosures to minimize distortion and give you a cleaner, more musical output. This feature makes sure you can be as LOUD as you want, without sacrificing sound quality.

ENGINEERED HIGH STRENGTH TERMINAL CUP

The terminal cup on our MAD 2 enclosures are made with a seamless single molding, 5mm thick round housing and an upraised design to withstand enormous amounts of pressure! We've also upgraded the cup with heavy duty binding posts to help you secure your connections properly (wrench included). This clever design choice makes sure that there'll be no rattling from the terminals - even when you dwell to the deepest bass levels!

HOW TO

INSTALL PRE-LOADED ENCLOSURE

Before installing your brand new pre-loaded enclosure, make sure that you have everything you need. Have the right tools ready, and make sure that you have the necessary knowledge /skill to perform the installation properly. Preparation and knowledge is crucial!

The MAD B2-112V uses two 2 Ohm voice coils. Since the enclosure is pre-loaded with a MAD S2 subwoofer, the installation is very simple. Just connect it with your amplifier and get ready for an awesome bass experience! Use the included wrench to secure your terminal connections properly. **NOTE! The enclosure has 1 Ohm pre-terminated impedance as its standard connection.**

With the MAD B2 enclosure terminal, you get the options to vary the impedance by altering the wiring between series or parallel configurations. Make sure to look through the wiring schematics on the next page and choose the setup that corresponds with your sound system. Take note of the impedance stability of your amplifier. Don't be afraid to consult your local GAS AUDIO POWER dealer/installer if you have any questions.



Make sure that the enclosure doesn't move around while driving, use the included mounting brackets and screws to securely fasten it in position.

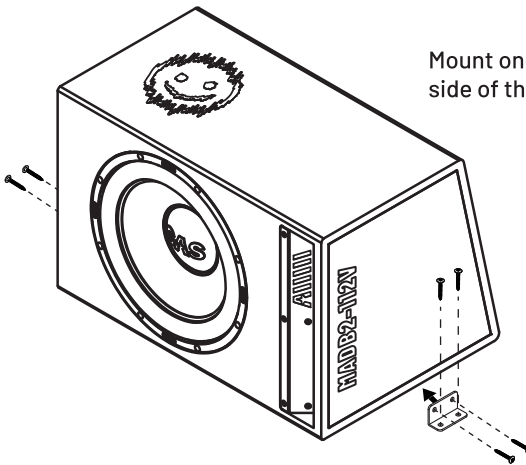

Mount one bracket on each side of the enclosure.

HOW TO

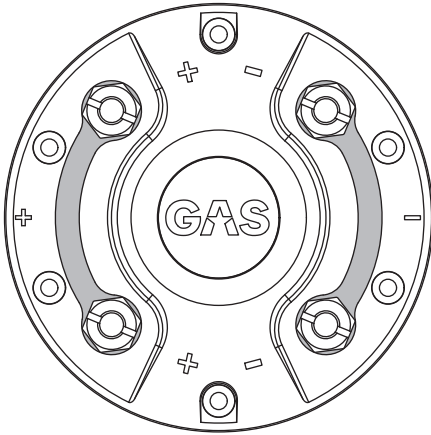

ENCLOSURE TERMINAL

- Includes pre-mounted bridging plates -

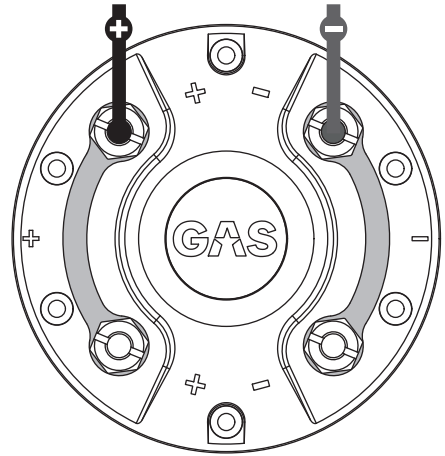

1 OHM

- Parallel/standard connection with plates -

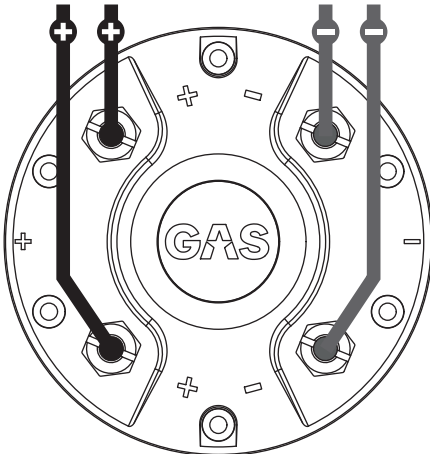

2+2 OHM

- Stereo/direct connection -

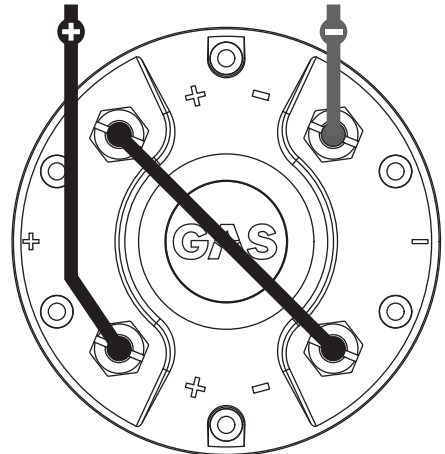

4 OHM

- Serial connection -



When you use the stereo or serial configurations on the enclosure, remember to first remove the pre-mounted bridging plates from the terminal.

TROUBLESHOOTING

NO POWER/SOUND

Check the enclosure/subwoofer to make sure it isn't damaged. If your pre-loaded enclosure doesn't get any power, the most common issue is either in the wiring or in the amplifier. Use a multimeter to measure the amplifier's voltage on the +12V terminal and the remote signal terminal. Make sure that you have a negative ground connection. Check the built-in fuse (if there is one) on the amplifier. If there's no power coming through - control the fuse on the power cable. If the fuse is intact you should check all of the wiring to ensure cable integrity.

DISTORTION

Start by looking over the enclosure/subwoofer so there's no damage or connection issue with the wiring. Check the speaker cables to make sure that the polarity isn't reversed on one channel. Check the settings on the amplifier, make sure that the gain/level function is set according to the amplifier's instructions. If your amplifier has a boost function, lower its effect or turn it off.

When all of the above has been tested/looked over, and all is as it should be but the pre-loaded enclosure still has no power/sound or other problems, consult your local GAS AUDIO POWER dealer/installer

WARRANTY & DISPOSAL

This product is covered by warranty, depending on the conditions in the country where it's sold. If the pre-loaded enclosure is returned for service, please include the original dated receipt (or a copy) with the product. Make sure that the enclosure is packaged properly and secured, preferably in its original packaging.



The crossed-out wheeie bin symbol means that the product, literature and packaging included must be taken to separate collection at the end of their working life. Don't dispose of these products as unsorted municipal waste: take them for recycling. For info on your nearest recycling point, check with your local waste authority.



This product has been granted with the CE certification mark to show that the product follows the health, safety, and environmental protection standards for products sold within the European Economic Area (EEA).



GAS Audio Power products comply with the relevant provisions of the RoHS Directive for the European Union. In common with all Electrical and Electronic Equipment (EEE) the product shouldn't be disposed of as household waste. Alternative arrangements may apply in other jurisdictions.



GAS Audio Power is a global partner of the European Mobile Media Association, an organization that focus on promoting the custom made mobile media installations to consumers.

THE GAS WORLD

You've entered the world of GAS. We aim to please, and we've made sure to have products made for you. No matter what stage of the LOUD-addiction you might find yourself in, there is a GAS product to fill your need.

MAD

Just starting out? The MAD series is made to play LOUD and to be the express lane to a no bullsh!t sound system that will make sure everyone can hear you coming!

MAX

The MAX series holds products made to deserve the center stage. Powerful, heavy duty and designed to be noticed. We made NO COMPROMISES because we know that you wouldn't accept it.

CMP

The CMP series has been developed for the crucial seconds when the dB-counter starts to tick. All CMP products have hand-picked, high quality, COMPETITION GRADE components and they are specially designed to withstand an awesome amount of power.



THANKS FOR JOINING GAS AUDIO POWER!



GAS
AUDIO POWER

GAS AUDIO POWER and SHAKY are registered trademarks by Winn Scandinavia AB and is protected by relevant laws and jurisdictions such as Copyright and Trademark laws.

Winn Scandinavia AB | Idrottsvägen 37, 70232 Örebro, Sweden | www.winnscandinavia.com

Winn Scandinavia AB reserves for possible typos, factual or numeric errors that may have been printed on any products, package designs, user manuals and/or other included accessories.





GAS
AUDIO POWER