

MAD USER MANUAL



MAD K2

K2-54 & K2-64

MADE TO PLAY LOUD

WE PLAY LOUD!!

We know what you want. You want it LOUD, and that is exactly what we do, what we live for. Vibrations, gut-punches and straight up loud music - that's what makes us tick. We won't dress up in fancy words or claim to be something we're not. We are the NO BULLSH!T car audio brand!









Every single product with the GAS logo on it is born out of passion, the same that has driven us for two generations and that will keep us rolling up to your neighbourhood, winning and pushing the limits for many generations to come!

It's up to you to choose your own level of loud, and if you don't like what we do that's OK. You are welcome back when you've had your first true GAS experience. We don't exclude, we don't judge and we do not make up any excuses for who we are.

We are GAS and we are proud to be LOUD!

GAS

TABLE OF CONTENT

 SAFETY.....	3
 UNPACKING.....	4
 DIMENSIONS.....	4
 SPECIFICATIONS.....	6
MAD K2-54.....	6
MAD K2-64.....	7
 FEATURES.....	8
A MAD speaker to fit every need.....	8
Make your car feel like new again.....	8
Designed to be durable.....	8
Swedish design, MAD sensibilities.....	8
Optimized for great sound.....	8
 HOW TO.....	9
Install component kit.....	9
Speaker & tweeter placement.....	10
Tweeter mounting options.....	11
Crossover level function.....	12
 TROUBLESHOOTING.....	13
No power/sound.....	13
Unwanted noise.....	13
Distortion.....	13
 WARRANTY & DISPOSAL	14
 THE GAS WORLD.....	15



SAFETY

PLAY LOUD & SAFE. Read through this information, follow the instructions and save the manual for future usage and reference.

Make sure to pay attention to the instructions when you see this symbol: 

Do not expose the wiring to your new speaker to excessive damp or moisture. If the speaker's wiring is exposed it might result in electric failure, shock or damage to the product. Servicing is required when the product has been damaged in any way and/or doesn't operate normally. Refer all servicing to qualified service personnel only.

Keep the cables inside the vehicle separate from sharp edges or components that may be affected or take damage. Follow the recommended cable sizes and always use high quality cables and accessories. Even if you're eager to put the speakers to use - take no shortcuts when installing the cables, make sure that all connectors are protected and secured.

Do not drill any holes without checking what lies beneath, and don't cut anything without making sure that no important components risk being damaged.

There is a first time for everything, if you need help - ask a friend or contact your local GAS AUDIO POWER dealer/installer.

We want you to experience your product's MAD sound, but we don't want you to injure yourself or others. Use common sense, respect high pressure levels and volume, and follow your local laws and regulations.



UNPACKING

Unboxing your new MAD product is an experience, make sure that the speakers and all the accessories are included in the packaging:



Speakers
(2pcs)

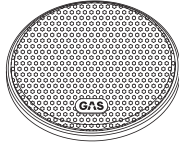

Grills
(2pcs)



Tweeters
(2pcs)



Crossovers
(2pcs)



Manual

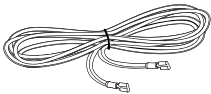

Crossover Cables
(4pcs)

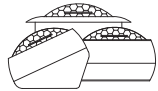

Tweeter houses
(6pcs)



Glue pad
(2pcs)

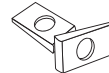

V-type clips
(12pcs)



Screws
(12pcs)

DIMENSIONS

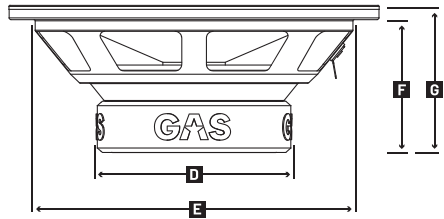
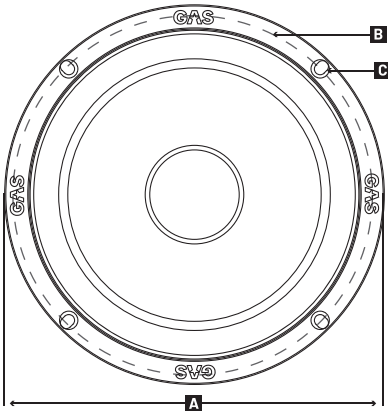

	A	B	C	D	E	F	G	
K2-54	Ø130	Ø139	4.8x9.8	Ø86	Ø113	47	53	mm
K2-64	Ø165	Ø155	5x6.6	Ø86	Ø142	60	66	mm

DIMENSIONS

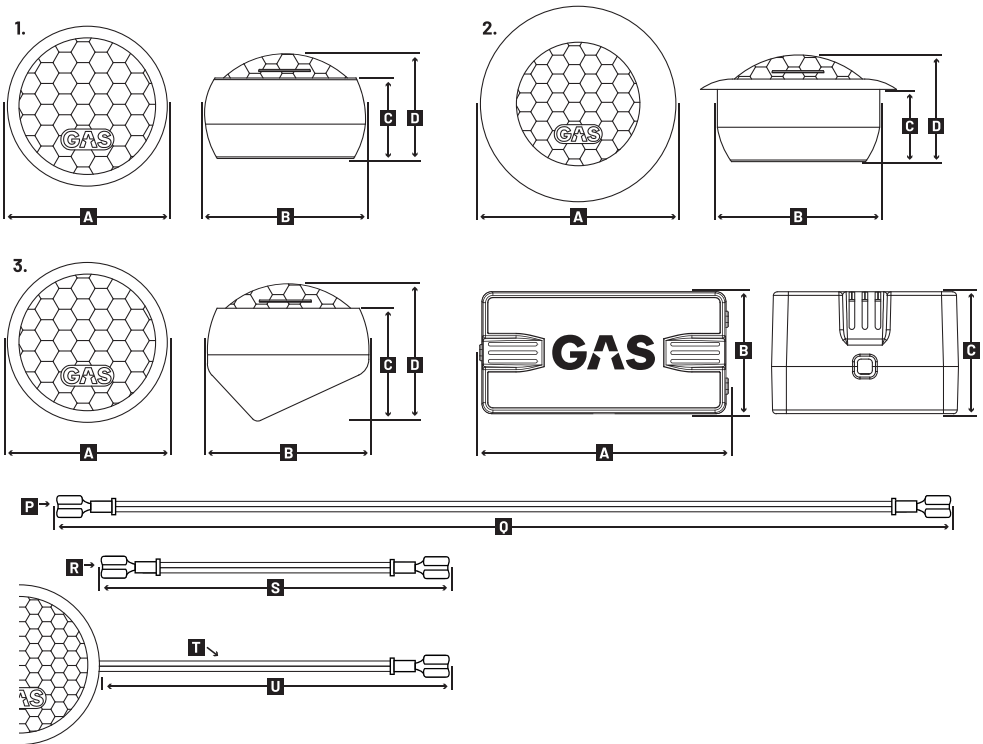

	A	B	C	D	
TWEETER HOUSING 1	Ø46.5	Ø46.5	24.3	31.3	mm
TWEETER HOUSING 2	Ø57	Ø47.2	21	31	mm
TWEETER HOUSING 3	Ø46.5	Ø46.5	34	41	mm

	A	B	C	
X-OVER	100	50	32.6	mm

	P	Q	R	S	T	U
CABLES	0.75 MM ²	300 CM	0.75 MM ²	100 CM	0.75 MM ²	100 CM

SPECIFICATIONS

Below you'll find the specifications that has been checked and tested in our workshop. The specified sensitivity isn't directly connected with the sound pressure in the vehicle, and shouldn't be used as the sole indicator for comparison with other component kits.

MAD K2-54

Component	Component kit
Woofers size	5,25" (116mm)
Tweeter size	1" (25mm)
Nominal impedance	4 Ohm
Power RMS	90W
Power MAX	180W
Freq. response	70-21 000Hz
Sensitivity	91dB

MAD K2-54 TWEETER

Tweeter dome	Silk
Tweeter magnet	Neodymium
FS	1276Hz
Sensitivity	94dB

MAD K2-54 CROSSOVER

Type	High / Low pass
Slope	12 / 6 db
Cut off	4500 / 4500 Hz
Tweeter level	High / Low

MAD K2-54 WOOFER

Woofers cone	IMPP + USG
Woofers basket	Resonance Free Steel
Woofers suspension	NBR Rubber
Woofers magnet	HQ Ferrite
Woofers spider	Nomex/Cotton
FS	87,17Hz
VAS	4,12L
QTS	0,93
QES	1,26
QMS	3,48
RE	3,5 Ohm
Sensitivity	89dB

SPECIFICATIONS

MAD K2-64

Component	Component kit
Woofer size	6,5" (165mm)
Tweeter size	1" (25mm)
Nominal impedance	4 Ohm
Power RMS	120W
Power MAX	240W
Freq. response	60-21 000Hz
Sensitivity	92dB

MAD K2-64 TWEETER

Tweeter dome	Silk
Tweeter magnet	Neodymium
FS	1276Hz
Sensitivity	94dB

MAD K2-64 CROSSOVER

Type	High / Low pass
Slope	12 / 6 db
Cut off	4500 / 4500 Hz
Tweeter level	High / Low

MAD K2-64 WOOFER

Woofer cone	IMPP + USG
Woofer basket	Resonance Free Steel
Woofer suspension	NBR Rubber
Woofer magnet	HQ Ferrite
Woofer spider	Nomex/Cotton
FS	69,58Hz
VAS	10,8L
QTS	0,93
QES	1,251
QMS	3,624
RE	3,4 Ohm
Sensitivity	90dB

FEATURES

The MAD K2 component kit is made to be LOUD and last for years to come. We want to help you and your vehicle to be as LOUD as possible. We've made sure that is the case by using innovative and groundbreaking techniques that increase durability.

A MAD SPEAKER TO FIT EVERY NEED

There's nothing better than replacing that old dusty wannabe speaker that's been hiding behind your door panel. Did your old speakers break 'cause they couldn't handle your level of LOUD? The K2 series 2-way component kit is ready for you. Be proud, be loud, be MAD!

MAKE YOUR CAR FEEL LIKE NEW AGAIN

Just the way you like it, just the way your car wants it – uncomplicated, LOUD and made to fit like a glove. For crisp and clear highs, we've included a 25mm silk dome tweeter with a Neodymium magnet. Place the tweeter wherever you want – it's your call! Included with the K2 series are three different multiple mounting accessories for the tweeter. Choose your tweeter location without holding back, LOUD upgrades fit everywhere!

DESIGNED TO BE DURABLE

Our research department has truly gone MAD! For our MAD S2 subwoofers we developed a new kind of IMPP cone & USG™ rubber woofer surround. We decided that these were so good – we brought them over to the K2 series. We've also added a hard PP dust cap, with a convex shape for better high frequency dispersion and off-axis response. All this packed in a small casing that makes the mounting real simple.

SWEDISH DESIGN, MAD SENSIBILITIES

The 25mm KSV voice coil is wound with lightweight CCAW (Copper Clad Aluminum Wire) that creates a dynamic sound, and the woofer surround is made out of resistant soft butyl. Since the Swedish weather encompasses all different seasons – the K2 series is designed to withstand them all. Hot, cold, UV rays – it doesn't matter. It's MAD and it's made to play LOUD, no matter the circumstances!

OPTIMIZED FOR GREAT SOUND

We took our sound obsession one step further, and a good component kit demands a good crossover. The crossover design for the tweeter is a 12db high pass filter with selectable level settings (high or low) and features a high quality capacitor and air core inductor. The K2 series woofer uses a 6 db low pass filter and air core inductor. All together it will keep down the distortion level for each component and optimize your new speakers within their limits. Now you can go as loud as you want, the way it was meant to be!

HOW TO

INSTALL COMPONENT KIT

Before installing your brand new component kit, make sure that you have everything you need. Have the right tools ready, and make sure that you have the necessary knowledge/skill to perform the installation properly. Preparation and knowledge is crucial!

The component kit includes three parts: the midrange woofers, the tweeters and the crossovers. The crossover should be wired before the midrange woofer and the tweeter, it makes sure that the woofer and tweeter plays on the right part of the LOUD spectrum.

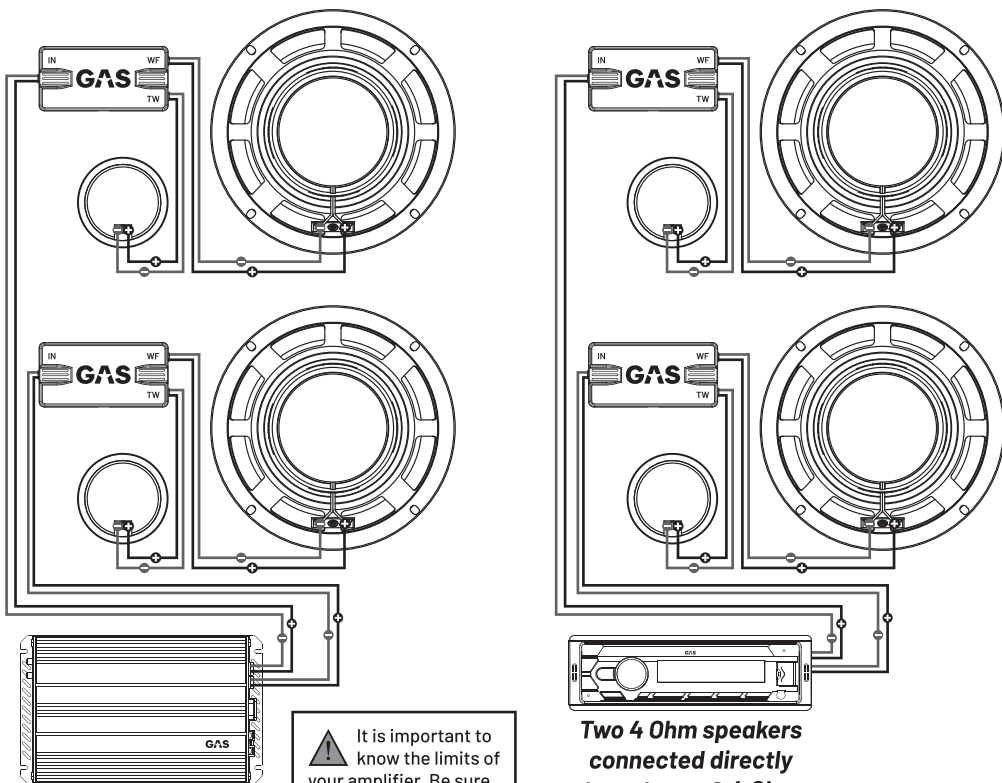

Two 4 Ohm speakers connected with an amplifier @ 4 Ohm

Two 4 Ohm speakers connected directly to a stereo @ 4 Ohm

 It is important to know the limits of your amplifier. Be sure to connect your sound system with a suitable impedance to optimize your sound system.

HOW TO

SPEAKER & TWEETER PLACEMENT

Now that you know how to connect your component kit, you need to decide where to put it. You will most likely have one or two possible locations to put the speakers and tweeters depending on make and model. This is where the fun begins!

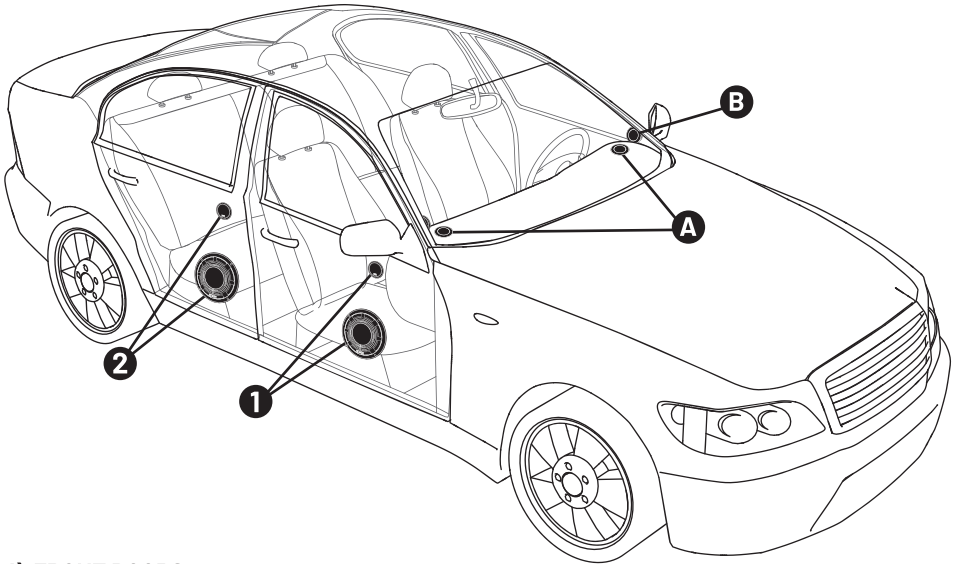

1) FRONT DOORS

The front right and left doors are typical positions for woofer placement! In some models you'll find original speakers in the kickpanel - right in front of the doors in the footwell.

2) BACK DOORS

Some car models out there have a 2-way system in the back. If your car's on the more luxurious side of the spectrum, you might find a component kit in both the front and rear.

A) DASH

The tweeter is usually placed here. Do you see a small grill around the left and right end of the dash? Awesome! Put your new tweeter here. If your car's a bit older, you might not have a tweeter in your dash. No worries! Use the ANGLED SURFACE MOUNTING and you're good.

B) A-pillar

In some cars, the tweeter is located in the A-pillar. Lucky you! This is a great location to put a tweeter, since it's placed higher up and directly aimed at your ears. Place the tweeter with the ANGLED SURFACE MOUNTING and enjoy great sound!

HOW TO

TWEETER MOUNTING OPTIONS

With the K2 series component kit we've included three different types of housing for the tweeters, so you can choose the tweeter location most suitable for your ride and its sound system.

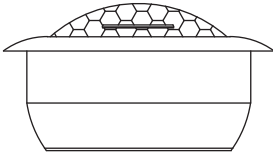

FLUSH MOUNTING

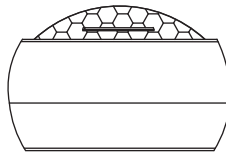

SURFACE MOUNTING

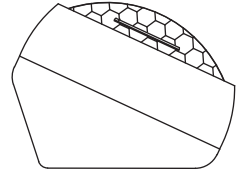

ANGLED SURFACE MOUNTING

Depending on the location, the housing might vary. If you want to change your OEM tweeters, use the FLUSH MOUNTING. Do you intend to put the K2 series tweeter on your dash? Great! Make sure to use the ANGLED SURFACE MOUNTING. The SURFACE MOUNTING has different exciting possibilities. Be creative. Make sure to aim the tweeters, so the sound reaches your head/ears for great results!

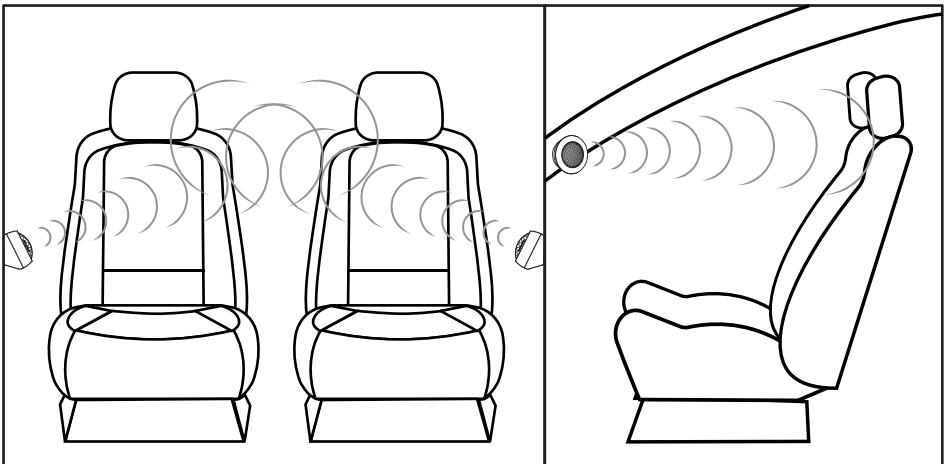

HOW TO

CROSSOVER LEVEL FUNCTION

The crossover included with the K2 series is made to give you an awesome sound experience that plays LOUD! The kit includes crossover cables with female flat pin connectors for easy installation.

On the crossover you can adjust the tweeter level setting between high or low tweeter level to affect the volume. This can be useful when the tweeters are installed on the dashboard or in the A-pillars. The switch is placed on the side of the crossover. Choose the low setting for LOUD, or the high setting for LOUDER!

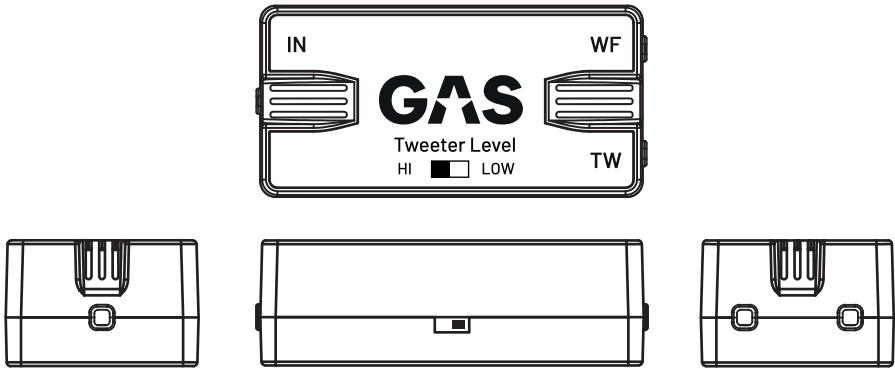

TROUBLESHOOTING

NO POWER/SOUND

Check the speakers to make sure they're not damaged. If your speakers don't get any power, the most common issue is either in the wiring or in the amplifier. Use a multimeter to measure the amplifier's voltage on the +12V terminal and the remote signal terminal. Use a multimeter to make sure that you have a negative ground connection. Check the built-in fuse (if there's one) on the amplifier. If there's no power coming through - control the fuse on the power cable. If it's intact - make a full check of the wiring to ensure cable integrity.

Check all the speakers connected to your sound system. Check all the speaker cables and all the signal cables. Check your head unit to make sure no settings are limiting the amplifier's functions or the speakers. When all of the above has been tested/looked over, and all is as it should be but there's still no sound, consult your local GAS AUDIO POWER dealer/installer.

UNWANTED NOISE

Start by looking over the speakers in the sound system so there is no damage or connection issue with the wiring. Make sure that your signal cables or speaker cables aren't too close to the power cables. Check your amplifier's grounding point and make sure that the surface is clean. When all of the above has been tested/looked over, and the unwanted noise does not vanish, consult your local GAS AUDIO POWER dealer/installer.

DISTORTION

Start by looking over the speakers in the sound system so there's no damage or connection issue with the wiring. Check the speaker cables to make sure that the polarity isn't reversed on one channel. Check the settings on the amplifier, make sure that the gain/level is set according to the amplifier's instructions. If your amplifier has a boost function, turn it down or turn it off.

WARRANTY & DISPOSAL

This product is covered by warranty, depending on the conditions in the country where it's sold. If the speakers are returned for service, please include the original dated receipt (or a copy) with the product. Make sure that the speakers are packaged properly and secured, preferably in its original packaging.



The crossed-out wheeie bin symbol means that the product, literature and packaging included must be taken to separate collection at the end of their working life. Don't dispose of these products as unsorted municipal waste: take them for recycling. For info on your nearest recycling point, check with your local waste authority.



This product has been granted with the CE certification mark to show that the product follows the health, safety, and environmental protection standards for products sold within the European Economic Area (EEA).



GAS Audio Power products comply with the relevant provisions of the RoHS Directive for the European Union. In common with all Electrical and Electronic Equipment (EEE) the product shouldn't be disposed of as household waste. Alternative arrangements may apply in other jurisdictions.



GAS Audio Power is a global partner of the European Mobile Media Association, an organization that focus on promoting the custom made mobile media installations to consumers.

THE GAS WORLD

You've entered the world of GAS. We aim to please, and we've made sure to have products made for you. No matter what stage of the LOUD-addiction you might find yourself in, there is a GAS product to fill your need.

MAD

Just starting out? The MAD series is made to play LOUD and to be the express lane to a no bullsh!t sound system that will make sure everyone can hear you coming!

MAX

The MAX series holds products made to deserve the center stage. Powerful, heavy duty and designed to be noticed. We made NO COMPROMISES because we know that you wouldn't accept it.

CMP

The CMP series has been developed for the crucial seconds when the dB-counter starts to tick. All CMP products have hand-picked, high quality, COMPETITION GRADE components and they are specially designed to withstand an awesome amount of power.



THANKS FOR JOINING GAS AUDIO POWER!



GAS
AUDIO POWER

GAS AUDIO POWER and SHAKY are registered trademarks by Winn Scandinavia AB and is protected by relevant laws and jurisdictions such as Copyright and Trademark laws.

Winn Scandinavia AB | Elementvägen 15, 70227 Örebro, Sweden | www.winnscandinavia.com

Winn Scandinavia AB reserves for possible typos, factual or numeric errors that may have been printed on any products, package designs, user manuals and/or other included accessories.





GAS
AUDIO POWER